

ONE ER32 H100

codice code **FL.ONE.00/100C63F-H1**

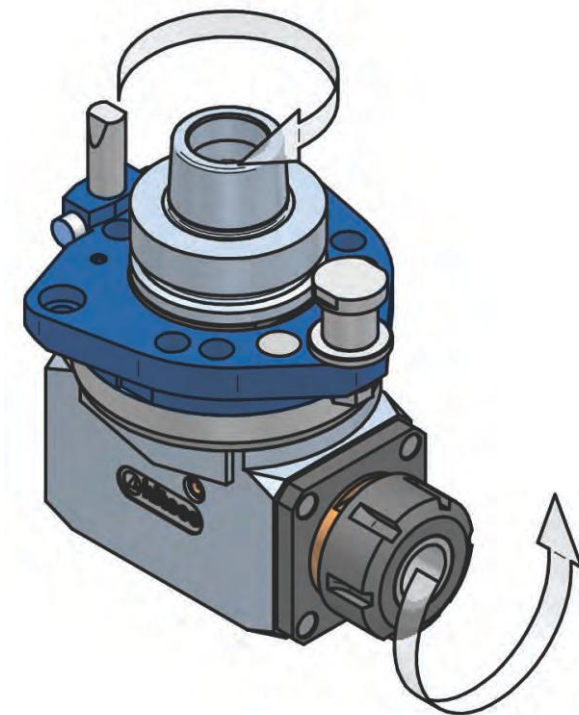

ONE ER32 H100

FL.ONE.00/100C63F-H1

Attacco mandrino Spindle coupling		HSK 63F
Velocità max. rotazione mandrino Max spindle speed	giri/min rpm	10850*
Velocità max. rotazione utensile Max tool speed	giri/min rpm	15500*
Senso rotazione mandrino Spindle rotation direction		vedi disegno see drawing
Possibilità inversione rotazione mandrino Possibility to change electrospindle direction		NO
Rapporto di trasmissione Gear ratio		1:1.43
Attacco utensile Tool coupling		ER32DX
Diametro codolo Tool shank diameter	mm	2 - 20
Diametro lama Blade diameter	mm	-
Diametro foro lama Hole blade diameter	mm	-
Peso Weight	Kg	4,2
Lubrificazione Lubrication		Grasso Grease
Temperatura max. Max temperature	°C/F	75 / 167
Orientamento angolare Aggregate rotation		0°/360° continuo continuous
Connessione asse C C axis connection type		H1

* vedere manuale see user manual



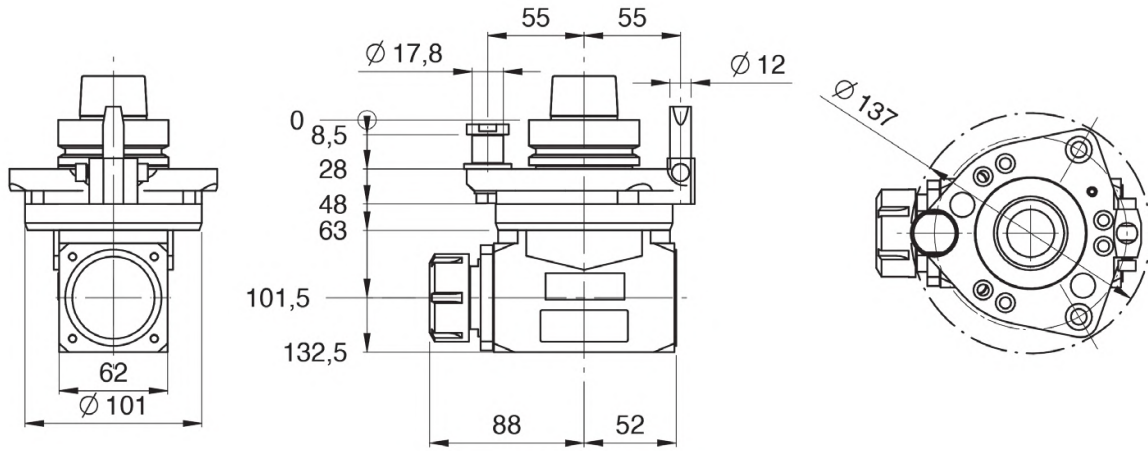

CONFIGURABILITÀ CONFIGURABILITY

FL.ONE.oo WWW-X-YYY-ZZ

ALTEZZA HEIGHT	WWW	
100	100	
145	145	
180	180	
ATTACCO UTENSILE TOOL HOLDER	X	
ER32	C	
ATTACCO MANDRINO SPINDLE INTERFACE	YYY	
HSK 63F	63F	
HSK 63E	63E	
ISO 30	I30	
ISO 30 SCM*	I3S	
RIFERIMENTI C AXIS CONNECTION	ZZ	
SCM HITECO 1 PIN	H1	
SCM 3 PIN - SCM 1 PIN - MORBIDELLI 3PIN - 1PIN	S3/(S1)	
ISO 30 SCM*	SS*	
BUSELLATO	BU	
BIESSE	BI	
CMS	CM	
SCM 1 PIN OLD	D1	
SCM/HITECO 3 PIN (con ut. pneumatiche with air supplies)	H3	
SCM/MORBIDELLI 3 PIN (con ut. pneumatiche with air supplies)	SP	
HOMAG (con ut. pneumatiche with air supplies)	HO	
VARIE SUNDRY ITEMS		
CHIP	CHIP	

* I3S compatibile solo con SS I3S only compatible with SS



Unità Aggregata / Aggregate Unit: **Fast Line One ER32 H180**
Codice/Code: **FL.ONE.00/180C63F-S3**

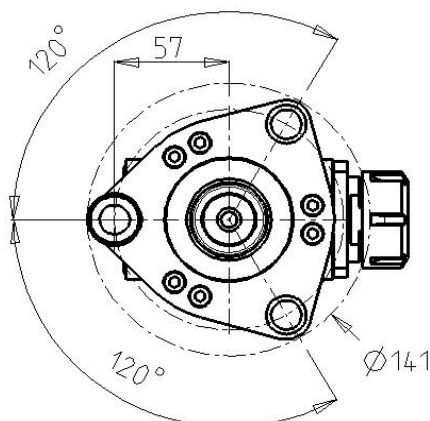
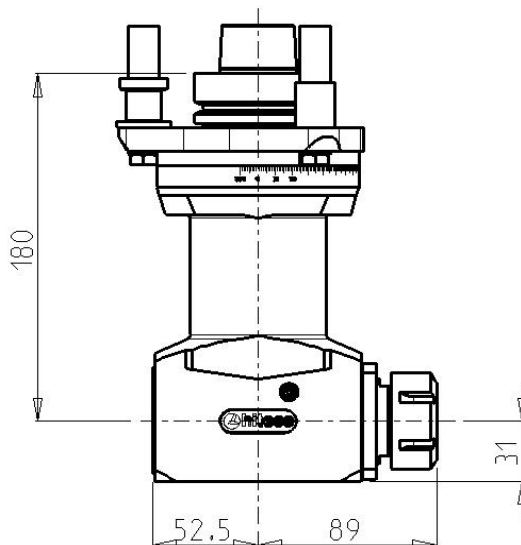
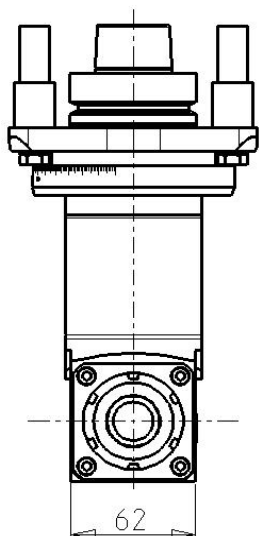

Specifiche tecniche / Technical specifications

Velocità rotazione mandrino/ Spindle speed	10850 rpm max <input type="checkbox"/>
Velocità rotazione utensile / Tool speed	15500 rpm max <input type="checkbox"/>
Rapporto di trasmissione / Gear ratio	1:1.43
Attacco mandrino / Spindle coupling	<input type="checkbox"/> <input type="checkbox"/> HSK 63F
Attacco utensile / Tool coupling	ER 32
Diametro codolo / Tool shank diameter	2 – 20
Diametro punta max / Max bit diameter	20
Diametro lama / Blade diameter	/
Peso / Weight	5,7 kg
Lubrificazione / Lubrication	grasso / grease
Temperatura / Temperature	75 °C / 167 F max
Orientamento angolare / aggregate rotation	0 – 360° in continuo / continuos
Connessione asse C / C axis connection type	<input type="checkbox"/> <input type="checkbox"/> SCM3 (schema 29L0054313B)

vedere grafico di utilizzo / see using diagram

altre versioni disponibili / other connections available

